

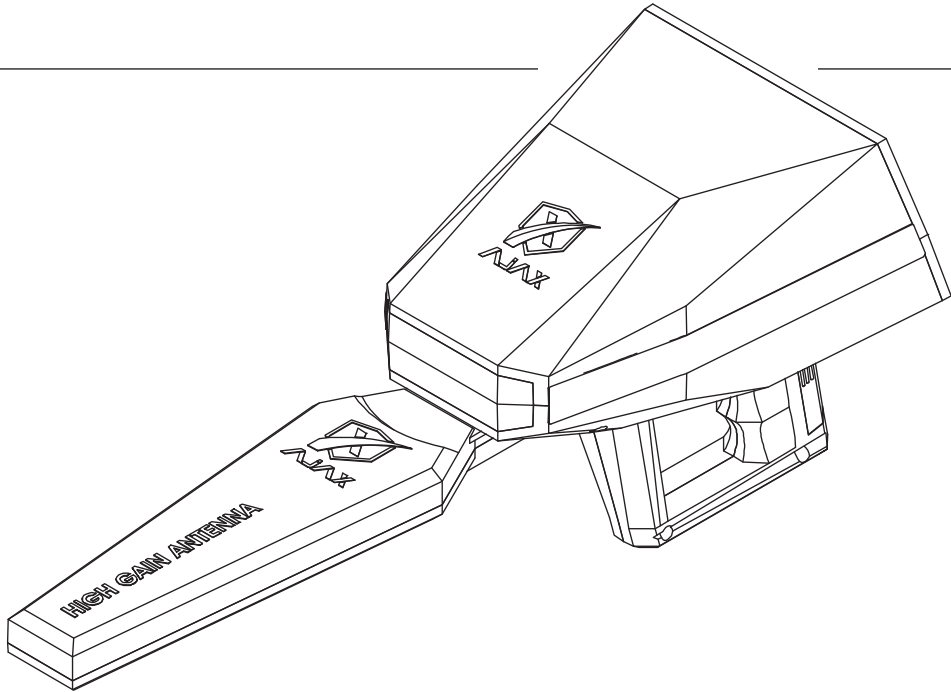

AJAX
DETECTION TECHNOLOGY

User Manual



iOTA

USER MANUAL

No part of this manual, including the products and software described in it, may be reproduced, transmitted, transcribed, stored in a retrieval system, or translated into any language in any form or by any means, except documentation kept by the purchaser for backup purposes, without the express written permission of AJAX DETECTION TECHNOLOGY LTD. (“AJAX”).

Product warranty or service will not be extended if: (1) the product is repaired, modified or altered, unless such repair, modification or alteration is authorized in writing by AJAX; or (2) the serial number of the product is defaced or missing.

AJAX PROVIDES THIS MANUAL “AS IS” WITHOUT WARRANTY OF ANY KIND, EITHER EXPRESS OR IMPLIED, INCLUDING BUT NOT LIMITED TO THE IMPLIED WARRANTIES FOR CONDITIONS OF MERCHANTABILITY OR FITNESS FOR A PARTICULAR PURPOSE. IN NO EVENT SHALL AJAX, ITS DIRECTORS, OFFICERS, EMPLOYEES OR AGENTS BE LIABLE FOR ANY INDIRECT, SPECIAL, INCIDENTAL, OR CONSEQUENTIAL DAMAGES (INCLUDING DAMAGES FOR LOSS OF PROFITS, LOSS OF BUSINESS, LOSS OF USE OR DATA, INTERRUPTION OF BUSINESS AND THE LIKE), EVEN IF AJAX HAS BEEN ADVISED OF THE POSSIBILITY OF SUCH DAMAGES ARISING FROM ANY DEFECT OR ERROR IN THIS MANUAL OR PRODUCT.

SPECIFICATIONS AND INFORMATION CONTAINED IN THIS MANUAL ARE FURNISHED FOR INFORMATIONAL USE ONLY, AND ARE SUBJECT TO CHANGE AT ANY TIME WITHOUT NOTICE, AND SHOULD NOT BE CONSTRUED AS A COMMITMENT BY AJAX. AJAX ASSUMES NO RESPONSIBILITY OR LIABILITY FOR ANY ERRORS OR INACCURACIES THAT MAY APPEAR IN THIS MANUAL, INCLUDING THE PRODUCTS AND SOFTWARE DESCRIBED IN IT.

Products and corporate names appearing in this manual may or may not be registered trademarks or copyrights of their respective companies, and are used only for identification explanation and to the owner’s benefit, without intent to infringe.

Contents

Safety Information	6
Where to find more information	6
Introduction	7
Specification Summary.....	8
Package Contents.....	9
Overview	11
Hard Keys.....	12
Battery Assembly	14
Assembly	15
Initial setup.....	16
User Interface.....	17
Main Menu	17
Settings	18
Language.....	18
Time and Date	18
Display	19
Sound	20
Power Mode	21
Storage	22
Info.....	23
Security.....	24
Reset	25
Quick Settings	26
Ionic Long-Range	27
Starting the Search.....	29
Ground Balance	30
Locating Target point and checking target	31
Depth Measuring	33
Save	34

Battery	36
Charging the battery	36
Precautions for operating environment	36
Battery charging tips and precautions	37
Contact Information	38
WEEE (Waste Electrical and Electronic Equipment) Statement	40

Safety Information

The components included in this package are prone to damage from electrostatic discharge [ESD]. Please adhere to the following instructions to ensure successful device assembly.



Ensure that all components are securely connected. Loose connections may cause the device to not recognize a component or fail to start.

Hold the device firmly when assembling or operating.

It is recommended to discharge yourself of static electricity by touching another metal object before handling the device.

Store the device in an electrostatic free environment whenever the device is not in use.

Do not assemble or operate the device before reading the user manual. This might cause permanent damage to the components as well as injury to the user.



If you need help during installation step, please consult support via phone or Online help-desk.



Always turn off the device before storing the device.

Keep this user manual for future reference.



Keep this device away from humidity.

Make sure that your electrical outlet provides the same voltage as is indicated on the Charger before connecting to the electrical outlet.

All cautions and warning on the device and in the user

manual should be noted.

If any of the following situations arises, get the device checked by service personnel:

Liquid has penetrated into the device.

The device has been exposed to moisture.

The device does not work well or you can not get it work according to user manual.

The device has been dropped or damaged.

The device has obvious sign of breakage.

Do not leave the device in an environment above 60°C (140°F), it may damage the device.



Where to find more information

Refer to the following sources for additional information and for product and software updates.

1. **AJAX websites:**

The AJAX website provides updated information on AJAX hardware and software products. Refer to the AJAX contact information.

2. **Optional documentation:**

Your product package may include optional documentation, such as warranty fliers, that may have been added by your dealer. These documents are not part of the standard package.

Introduction

iOTA is a unique long-range ionic search device with a horizontal range of 200m and an underground detection capability up to 20m.

The system is used to search for the ionic waves emitted by the old underground metal deposits.

The more time the deposits are underground, the higher the saturation field is.

The system works best with underground metal deposits buried for long periods of time (15 years and up), especially for precious metals (Gold, Silver...)

Time enables the ions to form a highly saturated field that can be sensed by the device.

The device also gives the user clear sound feedback indicating the location of the target, and a gradual increment in the levels of the sound indicator when the target is approached gradually.

In addition, the system has a quick response to the hidden targets unlike other devices utilizing the same system, as it has a focused electronic sense enabling target locating and guiding the user to the target site with the least amount of time and effort possible in a smooth and easy manner.

Thank you for purchasing the AJAX IOTA detection device.

This quick Start section provides demonstration about how to assemble your device .

Some of the installations also provide video demonstrations. Please link to the URL to watch it with the web browser on your phone or tablet. You may have even link to the URL by scanning the QR code.

Specification Summary

AJAX Detection Technology has been working on an innovation in detection field to expand the horizons and opportunities for new experience leading to efficient work-flow.

Research Principle	Multi-detection systems and functions
Operating Principle	Processing data and digital signals into visual and audio results
Processor Architecture	MIPS 32
Operation processor	M4K™ Core
Display Screen	TFT Color LCD, 800 x 480 WVGA, 16-bit color depth
Battery	Li-ion 7.4 volts, 3300 mAh
Power Rating	400 mA
Battery Endurance	Typical usage time 10 hours*
Power Adapter	240-100 VAC / 15 VDC
Storage	1 GB / it can save to 500 scans.
Sound	High quality sounds, 32 KBIT/S, MP3
Notifications	Sound and tactile feedback configurable in the settings menu for
Languages	Multilingual User Interface with 8 supported languages.
Date and Time	Real Time Clock could be set manually or Automatically via GPS time.
Login Restriction	Configurable PIN.
Storage	Available, up to 500 scans.
Dimensions	49X21X15 cm
Overall Dimensions	54x50x20 cm
Package Total Weight	3.3 kg
Assembly Weight	1 kg
Operating temperature	From -10° C to 60° C (14° F - 140° F)
Storage temperature	From -10° C to 80° C (14° F - 176° F)
Humidity	Could be stored and operated at relative humidity level up to 90%.

* Typical battery endurance is subjected to battery life degradation and environmental factors.

Package Contents

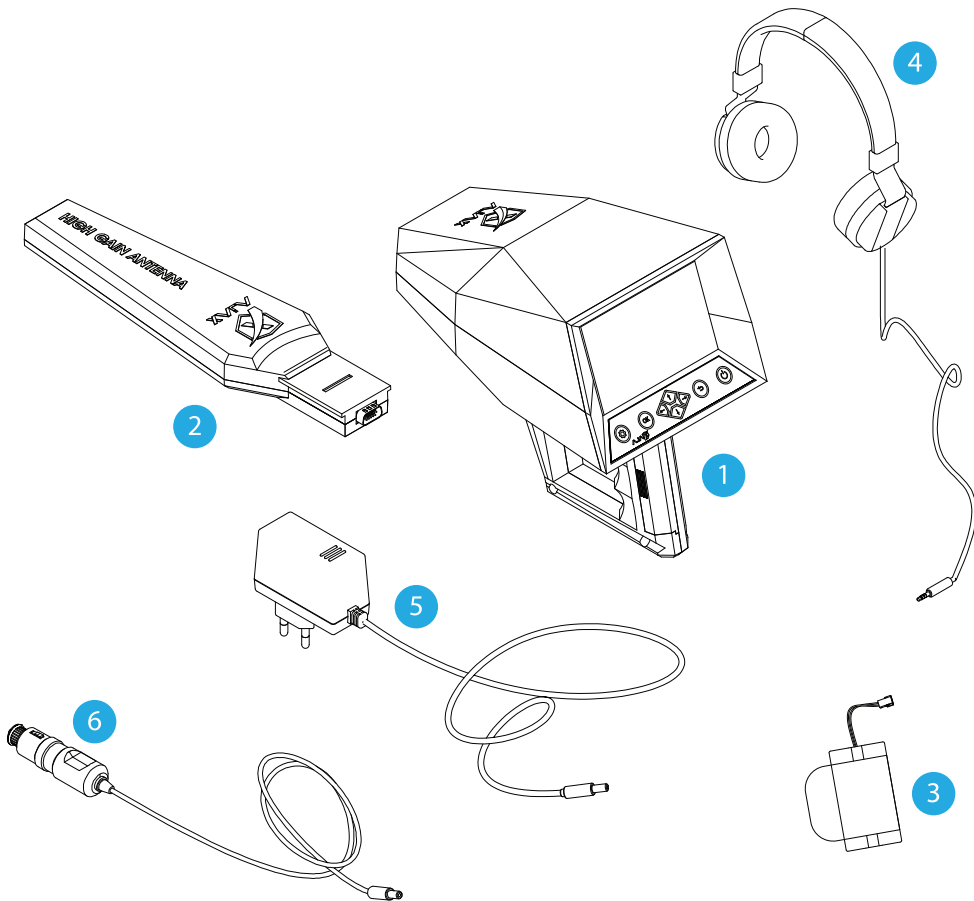

Package Contents

Check your device package for the following items:

1	Main Unit
2	High Gain Antenna
3	Battery Pack
4	Headphones
5	Charge Adaptor
6	Car Charger Adaptor

- The items supplied with the device and any available accessories may vary depending on the region or service provider.
- The supplied items are designed only for this device and may not be compatible with other devices.
- Appearances and specifications are subject to change without prior notice.
- You can purchase additional accessories from your local AJAX retailer. Make sure they are compatible with the device before purchase.
- Use only AJAX-approved accessories. Using unapproved accessories may cause the performance problems and malfunctions that are not covered by the warranty.
- Availability of all accessories is subject to change depending entirely on manufacturing companies. For more information about available accessories, go to the AJAX website.

Overview

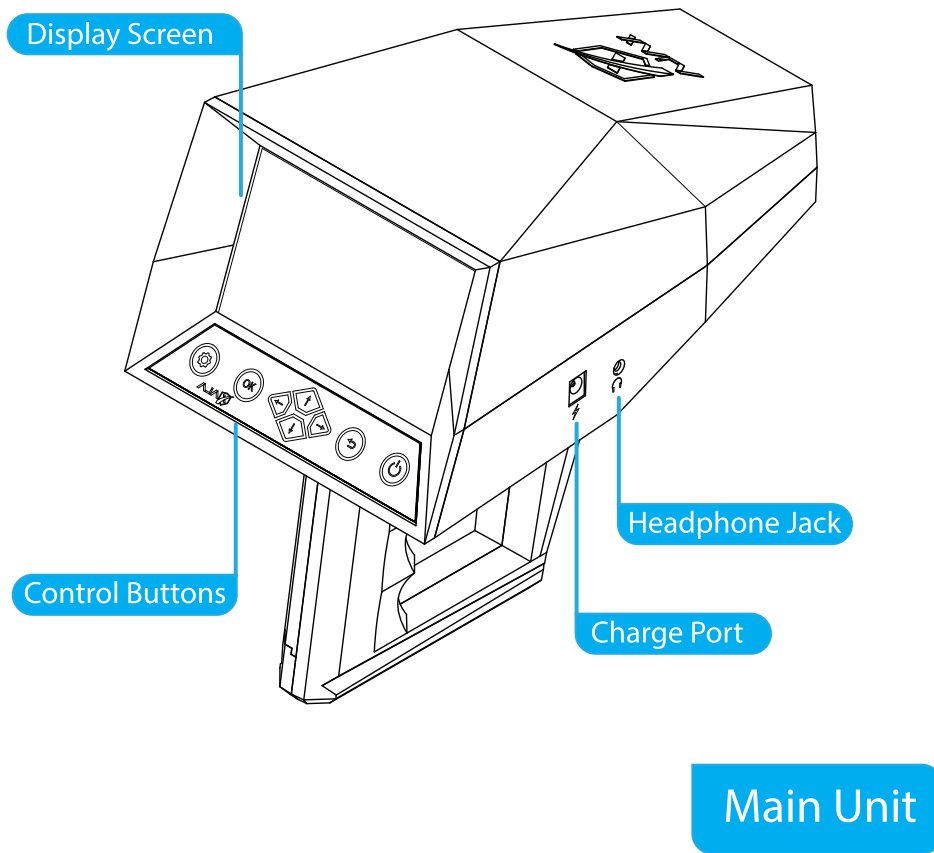

Hard Keys

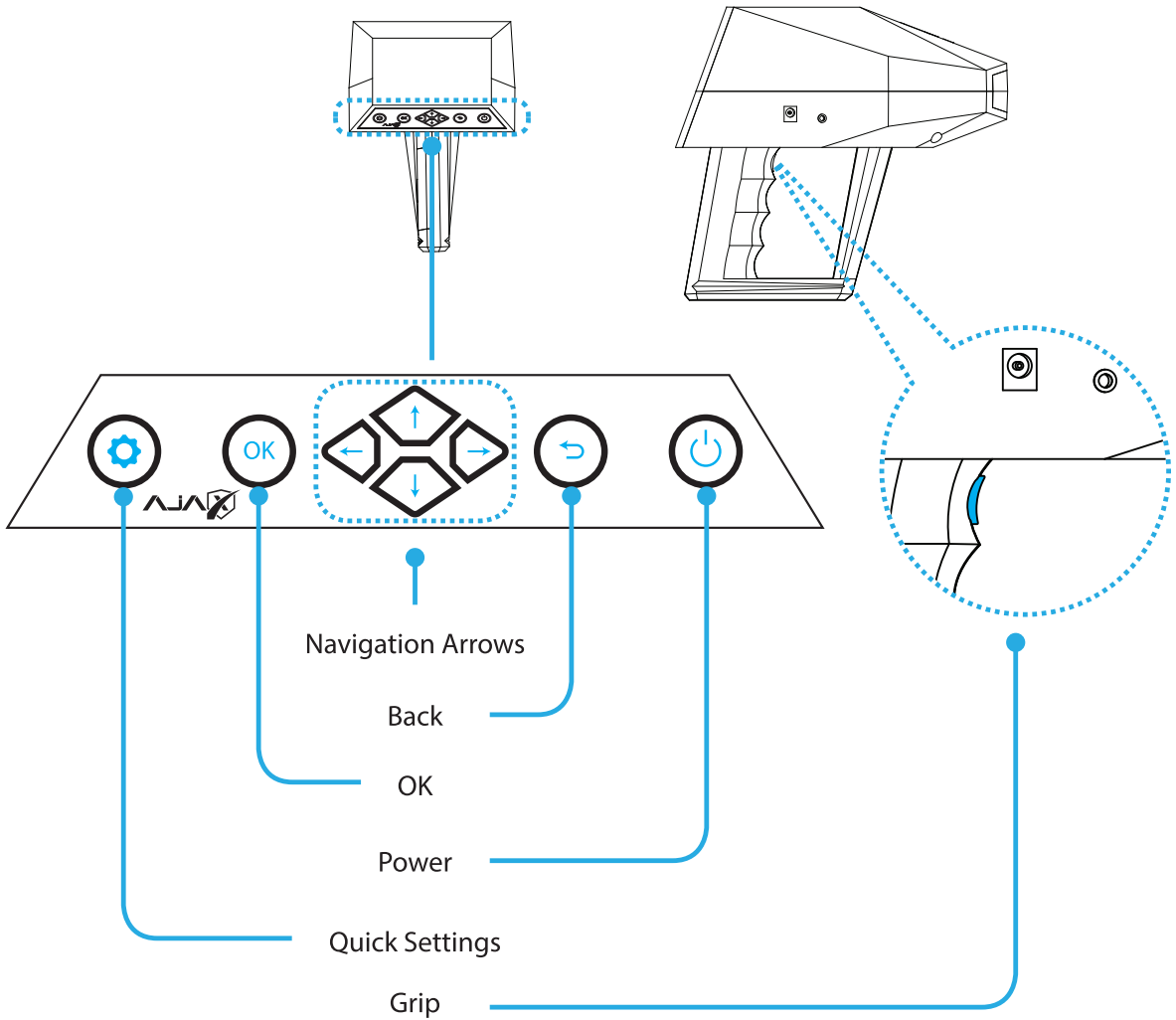

Hard Keys

Key	Function
Power	<ul style="list-style-type: none">• Press and hold to turn the device on or off.• Press to turn on or lock the screen.
OK	<ul style="list-style-type: none">• Confirm/enter the selected option.
Back	<ul style="list-style-type: none">• Go to previous menu, cancel.
Navigation Arrows	<ul style="list-style-type: none">• Navigation through the device interface.
Quick Settings	<ul style="list-style-type: none">• Press to drop the quick settings menu.
Grip Key	<ul style="list-style-type: none">• Multi-purposed key for ease of access while searching.

Turning the device on and off

Press and hold the Power key for a few seconds to turn on the device.

When you turn on your device for the first time or after performing a data reset, follow the on-screen

Instructions to set up your device.

To turn off the device, press and hold the Power key, and then tap Power off.

Follow all posted warnings and directions from authorized personnel in areas where

The use of wireless devices is restricted, such as airplanes and hospitals.

Battery Assembly

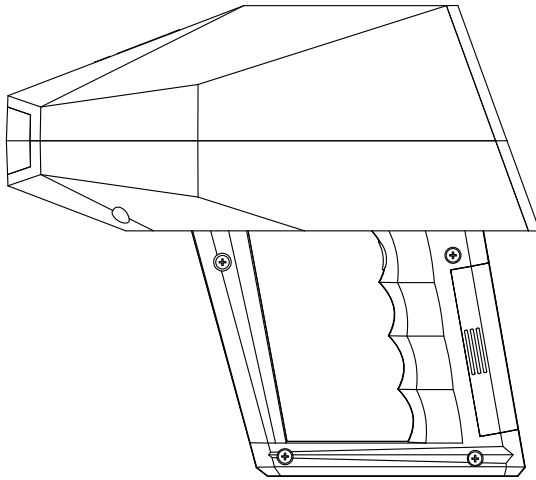
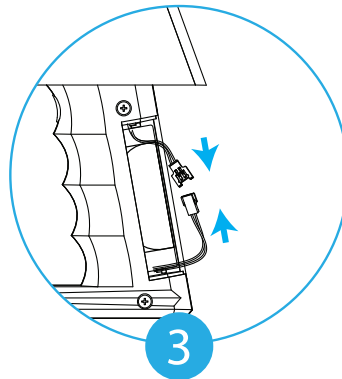
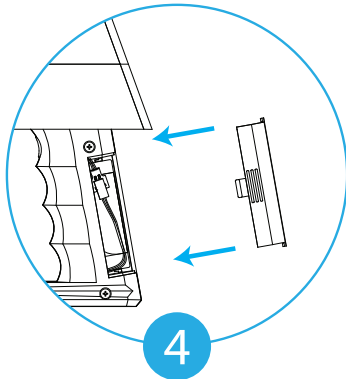
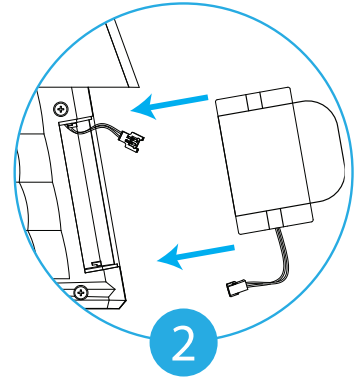
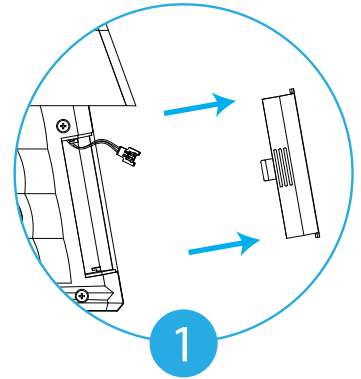
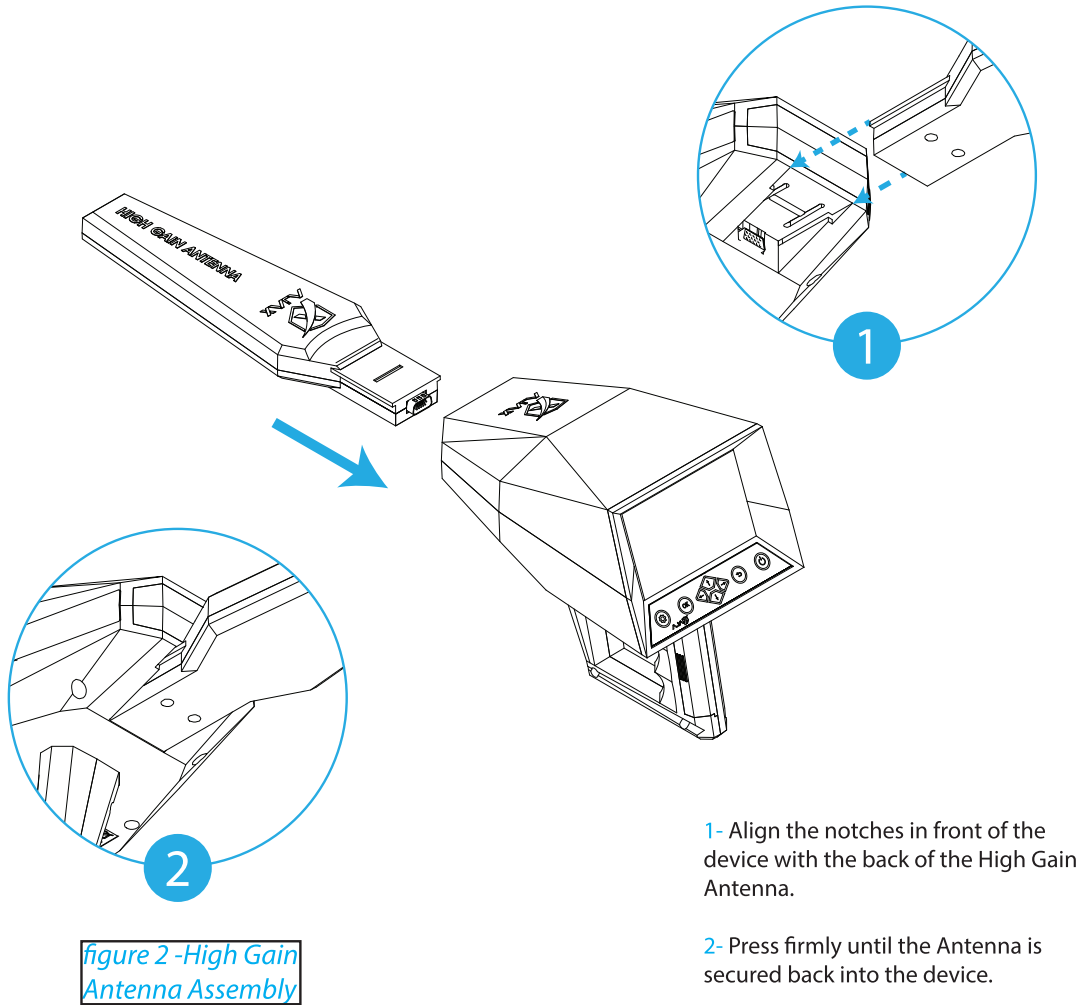

figure 1 -Battery Assembly



- 1- Press firmly at the ridges and push outwards to remove the battery cover.
- 2- Insert the battery pack inside the compartment.
- 3- Connect the wires and make sure they are securely attached.
- 4- Insert the connector inside the compartment and put the cover back on the grip.

Assembly



Initial setup

When running the device for the first time or after performing a data reset, follow the on-screen instructions to set up the device.

- The initial setup procedure may vary depending on the device's software and your region.



1 Turn on the device.

Press and hold to turn the device on

2 Select a language.

Select your preferred device language and select .

3 Set Time and Date.

Press   to move, and  to change values.

After setting the parameters the Main Menu will show on the display.

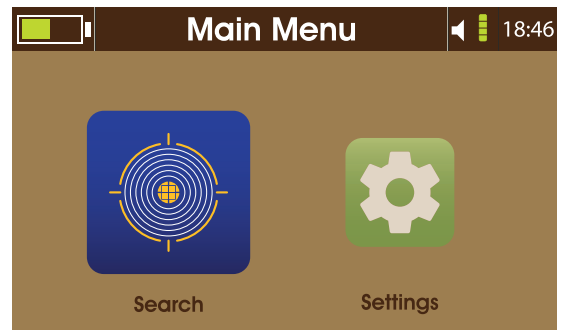

Note:

The time format is 24h (hh:mm) e.g. 19:42

The date format is day/month/year (DD/MM/yyyy) e.g. 30/03/2019.

Main Menu

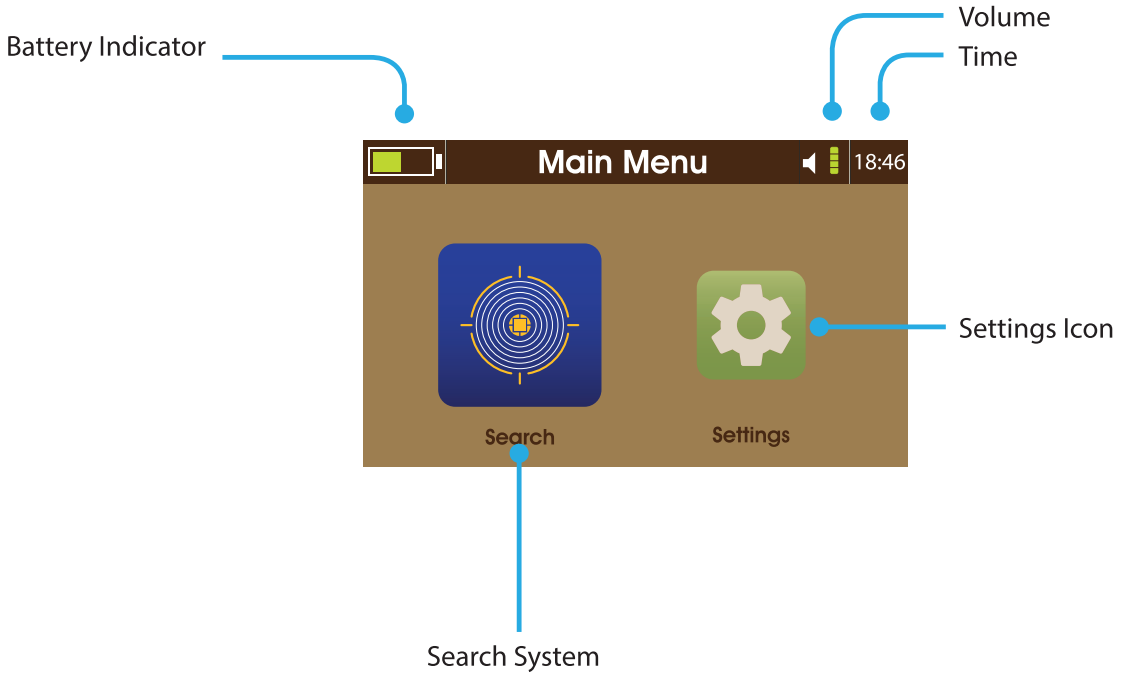

Settings

Language

The device supports 8 different languages for the interface (English, French, German, Spanish, Italian, Russian, Turkish and Arabic)

Select language and press  to set the language to the device.



Time and Date

Press   to move, and   to change values.

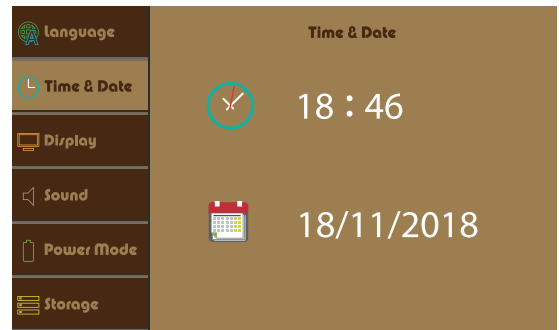

Note:

The time format is 24h (hh:mm) e.g. 19:42

The date format is day/month/year (DD/MM/yyyy) e.g. 30/03/2019.

Settings

Display

Brightness:

Move the brightness slider to adjust the brightness.
The value is adjustable from 0 to 100% brightness in a 1% increments.
Maximum brightness is 250 nits.

Sleep Mode:





Set the automatic dimming for the brightness to preserve power.

This setting can be set to 15, 30, 45 or 60 seconds, or it can be turned off completely.



Settings

Sound

Press   to move the cursor, press   to change the values, and press  to change mode.

I- General Volume:

This setting controls the volume for the notifications, errors, and the starting audio.

To set volume press  , and press  to change mode.

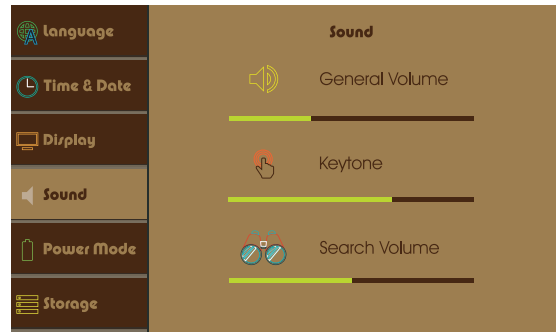

1- General mode

The device responds with vibration in addition to sound.



2- Silent mode

The device does not respond with any type of feedback



3- Vibration mode

The device only responds with vibration feedback



4- Normal mode

The device only responds with sound feedback



II- Key-tone:

This setting controls the volume for the feedback of pressing the buttons.

To set volume press  .

III- Search Volume:

This setting controls the volume for the search results and readings.



To set volume press  .

Note:

The key-tone volume and search volume are not set by the general volume.

Settings

Power Mode

This menu shows the power state of the device and current power mode, to change the power mode move the cursor   and press  to confirm.

I- Power Saving mode:



This mode saves power by disabling idle modules in order to preserve power for long search operations.

II- Optimum Mode:



This mode sets all of the device modules on for a steady performance and operation.

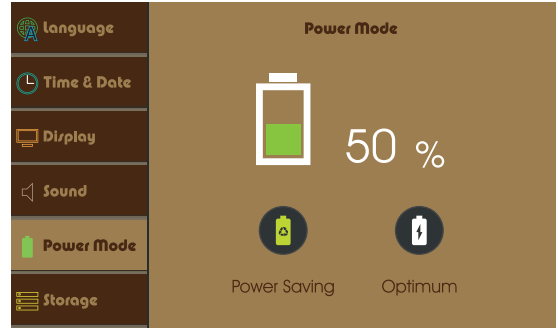

Settings

Storage

This menu shows the previously saved search results.

The user can view or delete the results.

Then the results list shows the saved searches

Navigate the list and press **OK** to view or delete the highlighted result.

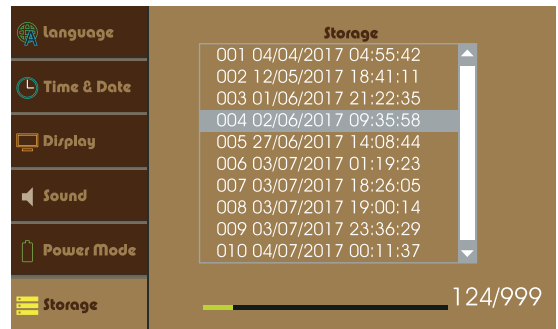

Settings

Info

This menu shows:

Device Version
Software Version
Model
Uptime

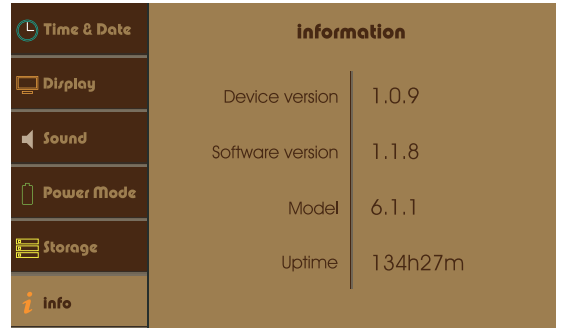

Settings

Security

This menu shows Secure Start state.

To change state press  then  to confirm.

Enter a new PIN then press .

Enter the PIN again for confirmation.

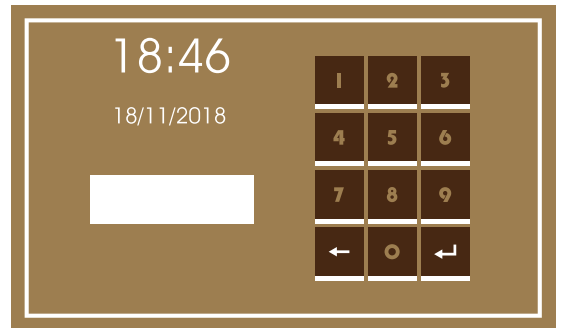
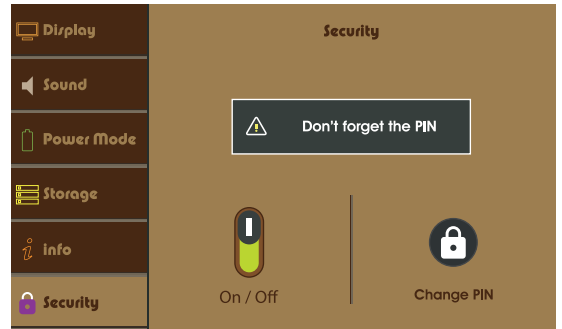

Settings

Reset

This menu shows the reinitializing options.

I- Clear Memory:

This option erase all saved results from memory.

II- Reset settings:

This option resets all the settings to default values.

III- Factory Reset:

This option resets all the settings to default values and erase all saved results.

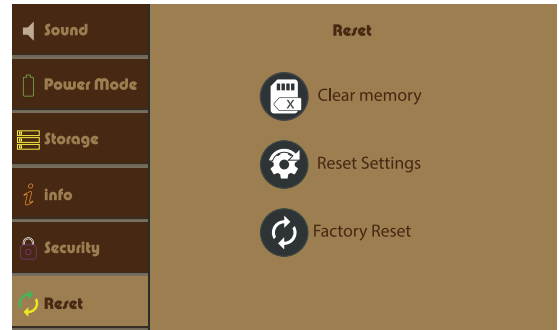





Quick Settings



To access the quick settings menu, press  key on the far left of the keypad.

When pressed, the title in the status bar will be replaced with the settings icons.

Press   to navigate through the options.







 Display Brightness. It can be set by pressing  to decrease or  to increase the brightness intensity.



 Sleep mode. It can be set to 5 settings 15, 30, 45 or 60 seconds or be set off completely.



 Power mode. It can be set by pressing  to change the power mode into:

 Optimum mode

 Power save mode

 Sound. Press  to increase or  to decrease the current value, while pressing  will change the sound value for the device keys  or the search .

"18:46" Time. Set the current time by pressing  or .

Note: To exit the quick settings menu press  or . The quick settings menu is accessible in every menu with a visible status bar.

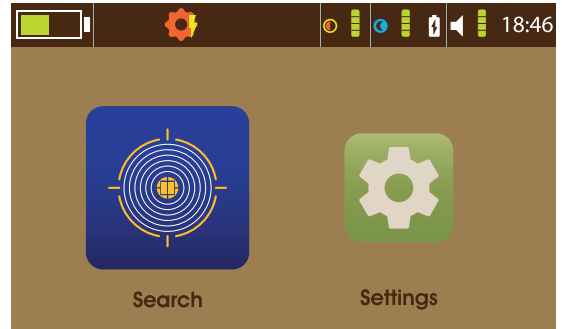

Ionic Long-Range

Select  from the Main Menu.

The High Gain Antenna must be connected first to proceed to the search interface.

Assemble the High Gain Antenna as shown in “figure 2 -High Gain Antenna Assembly” on page 15.

After connecting the High Gain Antenna, the display will show the search interface.

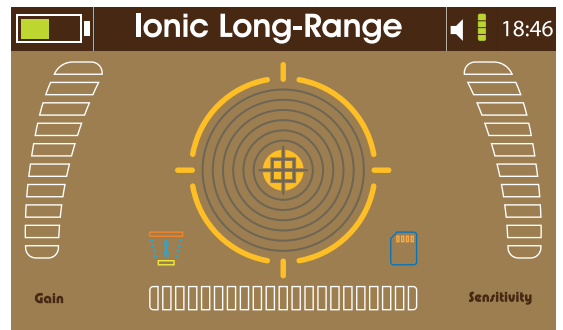
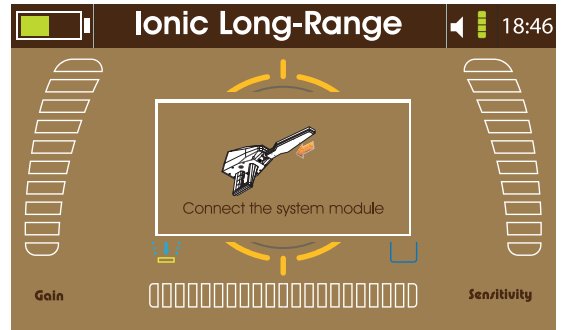
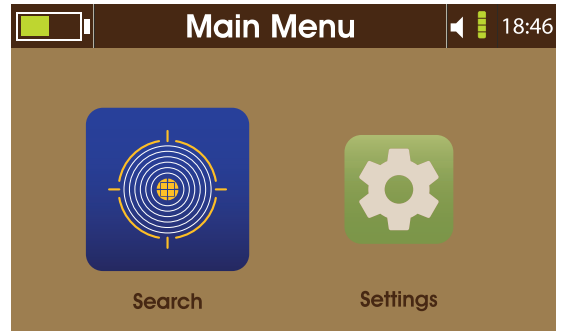

Ionic Long-Range

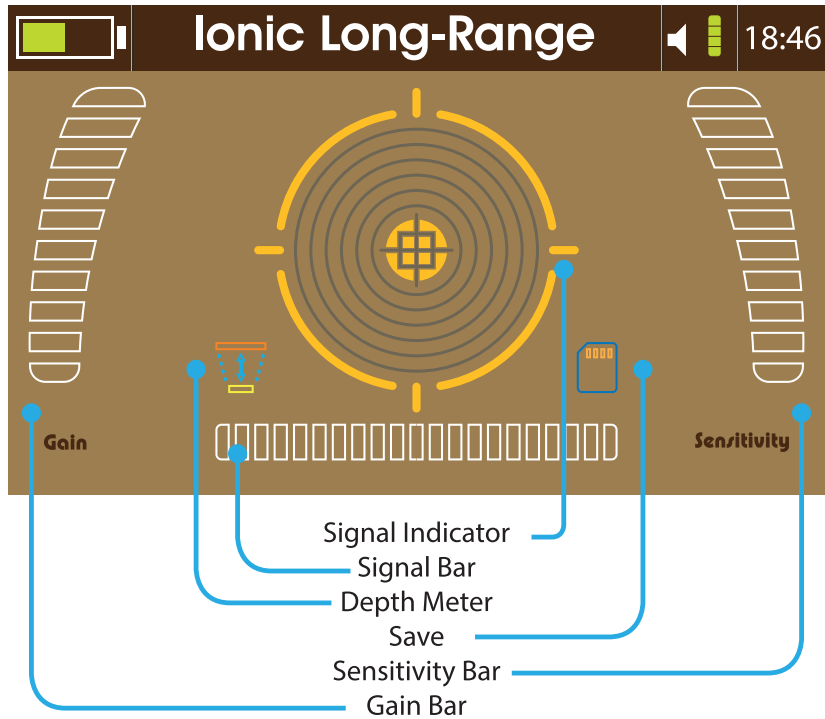

Starting the Search

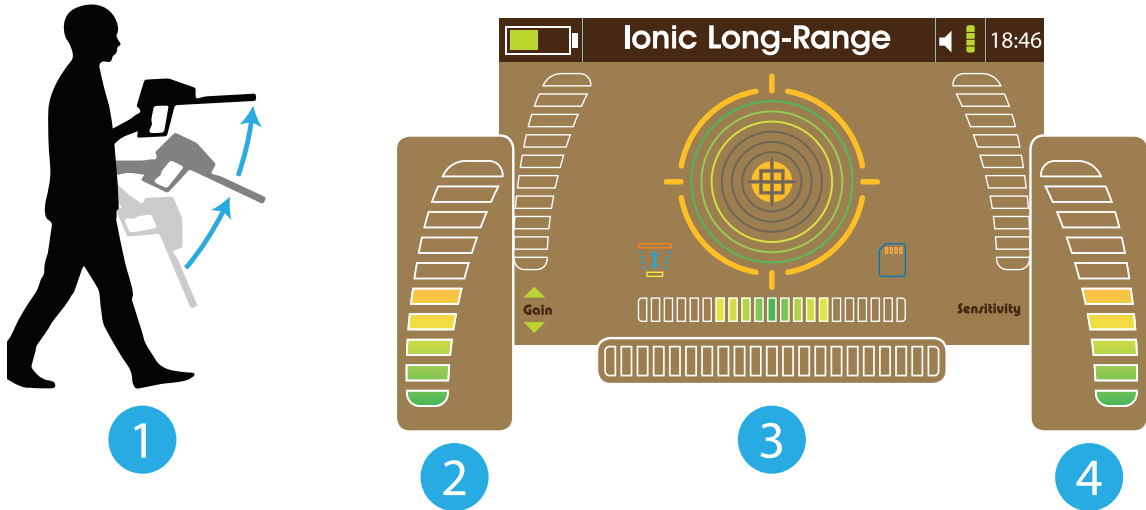

The device should be balanced with the ground value before proceeding into the search.

1- Lift the device in a horizontal position to the ground.

Don't move during the balance process.

2- Increase Gain value and notice the changes on the signal bar.

3- Keep increasing the gain bar value until the signal bar is stably set back to the middle and the tone stops.

4- Move the cursor over to sensitivity and increase the bar value to the middle.

The sensitivity level can be increased or decreased according to the regional conditions.

Then point the device towards target direction to hear the signal effect on the device.

If the signal is weak and slow, increase the sensitivity until the signal is clear.

The tone speed will increase as the target gets closer.

Ground Balance

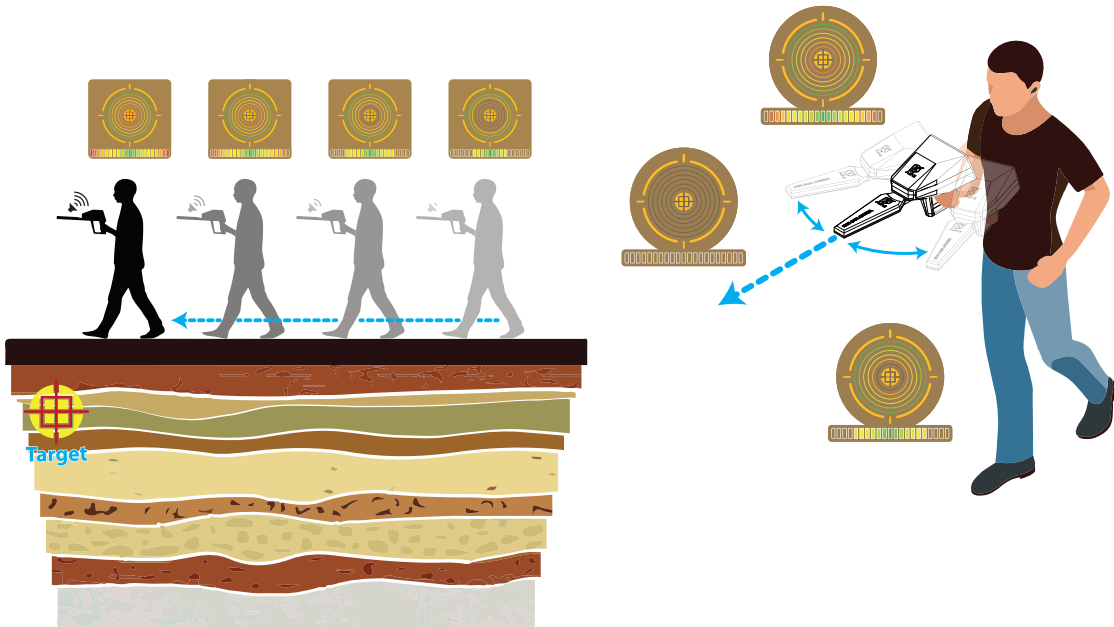

Hold the device horizontally and move it right and left until a signal indicating a probable target is received.

Then track that signal by moving towards target and watching the device display.

Note that the closer to target the device is the more rings will light up on screen and the sound will increase as well. The bottom indicator shows the received signal intensity. The rings will light gradually as the distance to the target decreases.

The indicator in the middle  will light up when the highest of signal occurs.

Locating Target point and checking target

To locate the target exact point, move the device up and down while performing the tracking process. That will identify the signal direction which provides the right tracking path to the target point.

For a more accurate target point locating, stand over the probable target point and aim the device towards the target. Then move forward until passing the target point, which will be indicated by a drop in the signal intensity on the device display.

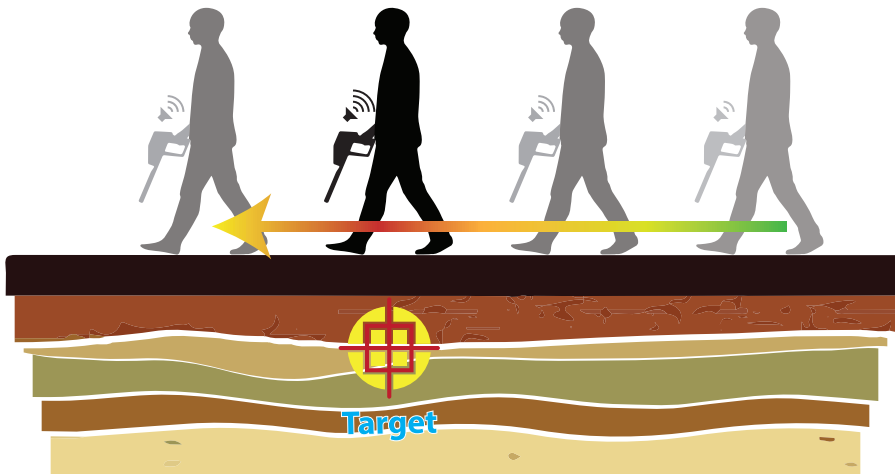
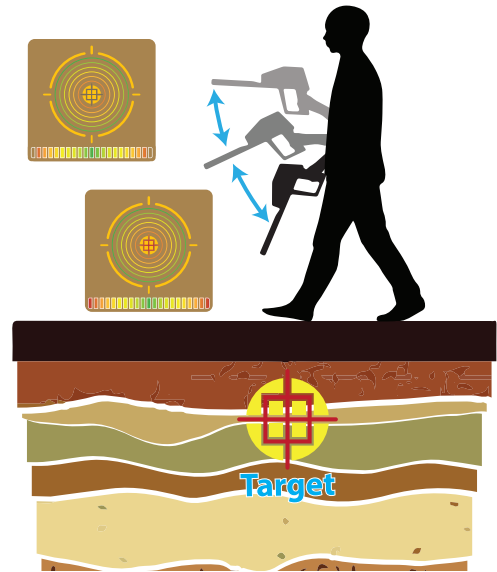

Locating Target point and checking target

Repeat this process from four different directions to identify the probable target borders and enclose it more accurately.

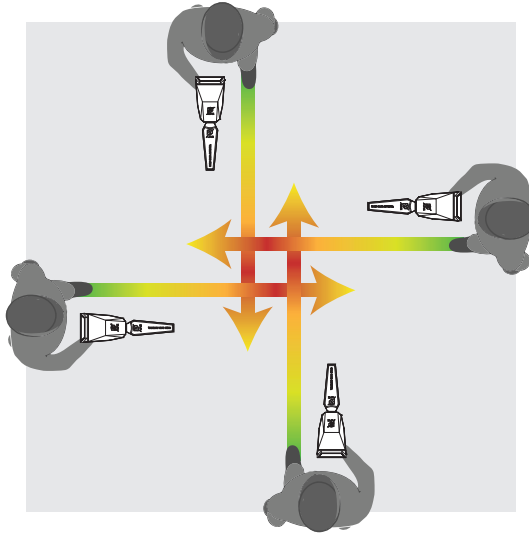

Once the target point is enclosed and located, mark it and proceed to the Depth measuring process next.

Depth Measuring

After locating the target position by received signals intensities.

1- Select Depth icon on the search display .

2- After accessing Depth meter interface, a screen will prompt pressing the grip key.

3- Point the device vertically towards the ground and press the grip key once then start walking straight forward until the tone from the device indicates the end of the depth measuring process.



4- The device processes the static electricity intensities of target ions. And based on that, the results will show the estimated depth value.

5- The depth meter interface shows an illustration for the ground levels up to 20m.

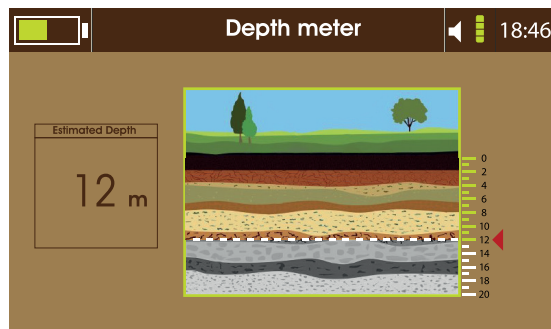
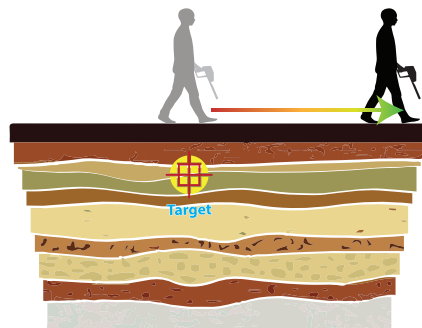
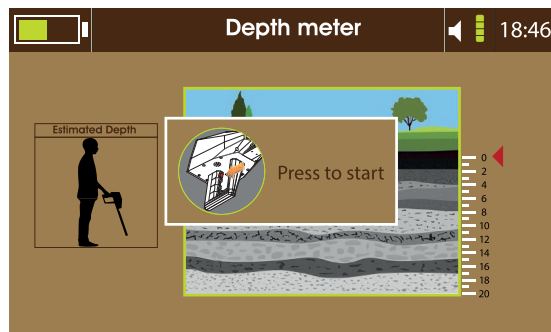
After the measuring process is finished a line will show the determined depth and the value will be shown in the designated box.



Save

Select save icon  on the search interface and press  to take the results on display and store them in the device memory for future use. The result contains the Gain and Sensitivity levels as the signal intensity along with the date and time.

To view saved results, go to settings then storage and select the system, a list of the previously saved results will be shown.

The results can be viewed or deleted.

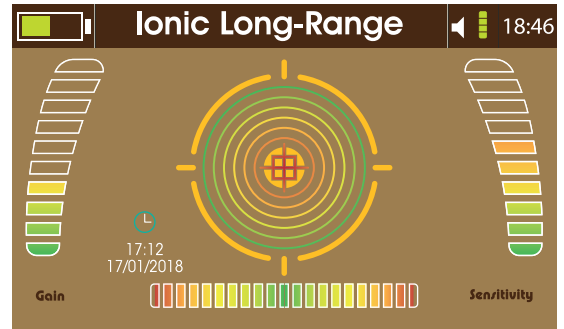

This page is left blank intentionally.

Battery

Charging the battery

Charge the battery before using it for the first time or when it has been unused for extended periods.

Use only AJAX-approved chargers, batteries, and cables.

Unapproved chargers or cables can cause the battery to explode or damage the device.

- Connecting the charger improperly may cause serious damage to the device.

Any damage caused by misuse is not covered by the warranty.

- Use only cable supplied with the device. The device may be damaged if you use different cable.

To save energy, unplug the charger when not in use.

The charger does not have a power switch, so you must unplug the charger from the electric socket when not in use to avoid wasting power.

The charger should remain close to the electric socket and easily accessible while charging.

1 Plug the DC cable into the device's Charge jack.

2 Plug the power adapter into an electric socket.

3 After fully charging, disconnect the charger from the device.

Then, unplug the charger from the electric socket.

Precautions for operating environment

Your device may heat up due to the environment in the following conditions.

Use caution to avoid shortening the battery's lifespan, damaging the device, or causing a fire.

- Do not store your device in extreme cold or hot temperatures.
- Do not expose your device to direct sunlight for extended periods.
- Do not use or store your device for extended periods in very hot areas, such as inside a car in the summertime.
- Do not place the device in any areas that may overheat, such as on an electric heating mat.
- Do not store your device near or in heaters, microwaves, hot cooking equipment, or high pressure containers.
- Never use a damaged charger or battery.

Battery

Battery charging tips and precautions

- When the battery power is low, the battery icon appears empty.
- If the battery is completely discharged, the device cannot be turned on immediately when the charger is connected. Allow a depleted battery to charge for a few minutes before turning on the device.
- The device can be used while it is charging, but it may take longer to fully charge the battery.
- If the device receives an unstable power supply while charging, the device may not function. If this happens, unplug the charger from the device.
- While charging, the device and the charger may heat up. This is normal and should not affect the device's lifespan or performance. If the battery gets hotter than usual, the charger may stop charging.
- If the device is not charging properly, take the device and the charger to AJAX or an AJAX Authorized Service Centre.

Contact Information

AJAX DETECTION TECHNOLOGY LTD.

Address 1201 N.W. Briarcliff Parkway, 2nd Floor,
Kansas City, Missouri, 64116 USA

Telephone +1 816 298 0485
+1 816 399 3744

E-mail info@ajaxdetection.com
Web site <http://www.ajaxdetection.com>

WEEE (Waste Electrical and Electronic Equipment) Statement

To protect the global environment and as an environmentalist, AJAX must remind you that... Under the European Union ("EU") Directive on Waste Electrical and Electronic Equipment, Directive 2002/96/EC, which takes effect on August 13, 2005, products of "electrical and electronic equipment" cannot be discarded as municipal waste anymore, and manufacturers of covered electronic equipment will be obligated to take back such product at the end of their useful life. AJAX will comply with the product take back requirements at the end of life of AJAX-branded products that are sold into the EU. You can return these products to local collection points.

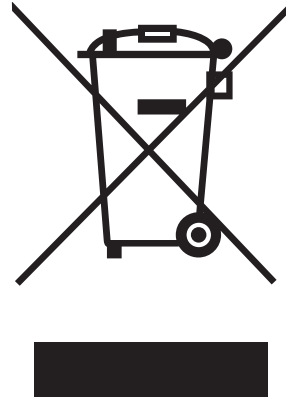

Environmental Policy

The product has been designed to enable proper reuse of parts and recycling and should not be thrown away at its end of life.

Users should contact the local authorized point of collection for recycling and disposing of their end-of-life products.

Visit the AJAX website and locate a nearby distributor for further recycling information.

Users may also reach us at <envo@ajaxdetcor.com> for information regarding proper Disposal, Take-back, Recycling, and Disassembly of AJAX products.



WEEE (Waste Electrical and Electronic Equipment) Statement

European Union:



Batteries, battery packs, and accumulators should not be disposed of as unsorted household waste. Please use the public collection system to return, recycle, or treat them in compliance with the local regulations.

Taiwan:

廢電池請回收



For better environmental protection, waste batteries should be collected separately for recycling or special disposal.

California, USA:



The button cell and Li-ion battery may contain perchlorate material and requires special handling when recycled or disposed of in California.

For further information please visit:

<http://www.dtsc.ca.gov/hazardouswaste/perchlorate/>



AJAX
DETECTION TECHNOLOGY

www.ajaxdetector.com